

ASL-2 Series 120V Track Lighting System

Altman Lighting is proud to offer the ASL-2 Series track lighting systems. The ASL-2 Series is based on the Global TEK track from Nordic Aluminum.

Superior performance for dimmed lighting, low life-cycle cost, and high power handling capability make Global track TEK lighting an excellent choice.

Global TEK 2-circuit/2-neutral track is ideal for dimming intensive applications. The independent neutrals guarantee that the two circuits are completely isolated. Cross-circuit interference and neutral harmonics are completely eliminated, essential for trouble free dimming. The lack of harmonics ensures superior fixture performance and longer equipment life. Independent neutrals also offer twice the power handling capacity of ordinary common neutral track.

Global TEK track is engineered to be durable, dependable, and simple-to-install lighting solution. The track's extruded aluminum construction and continuously crimped conductor ensure mechanical strength and electrical reliability. The integral suspension rail and predrilled mounting holes of the track simplify installations.

Product Features:

- Independent Neutrals – enable greater power capacity (2 x 20A) Dimming capability-dim on two independent circuits without harmonics or interference on the neutral conductor.
- Oversized Conductors – for higher operating safety and reduced overload potential.
- Secure Bus Bar Insulation – firmly crimped insulation secures both conductors and insulation for the life of product.
- Separate Mechanical Suspension Points – provides superior weight bearing capacity; ensures electrical contact integrity and reduces likelihood of arcing.
- Polarity Ridge – takes the guesswork out of connector and track alignment during installation.
- Multiple Mounting Options including Pendant, Aircraft Cable, and Direct Ceiling
- Two-circuit track with separate neutrals for 120 Volt applications
- Track can easily be cut in the field
- Rugged design supports up to 22-pounds per foot when installed according to instructions
- Multiple options for track coupling allowing for just about any layout design
- Complete line of:
 - Live End Feeds
 - Dead End Caps
 - In-Line Couplers
 - Feed Thru Connections
 - L-Turns (left and right)
 - Flexible Couplers
 - "X" Connectors
 - "T" Connectors
- Available in black, white and silver (natural finish)
- cULus Listed and CE marked for indoor use
- Two-year warranty

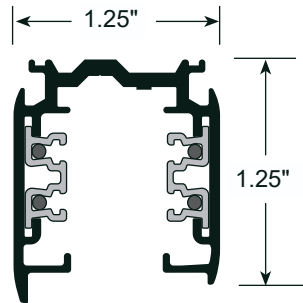
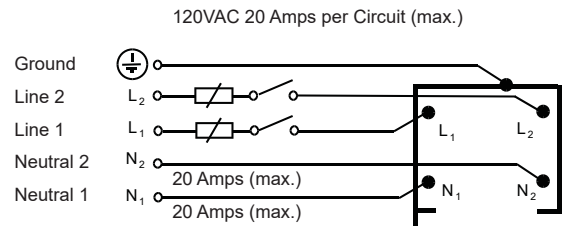
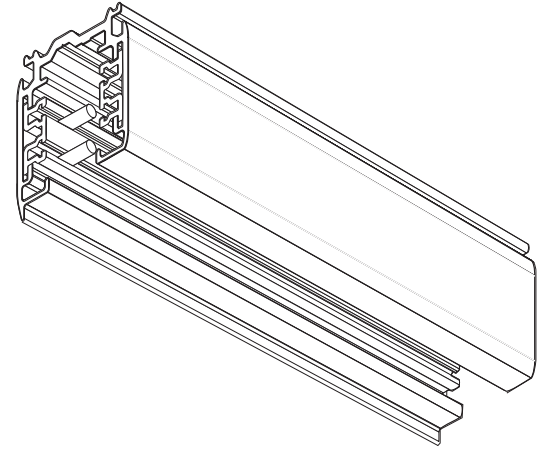

ASL-2 Series Track

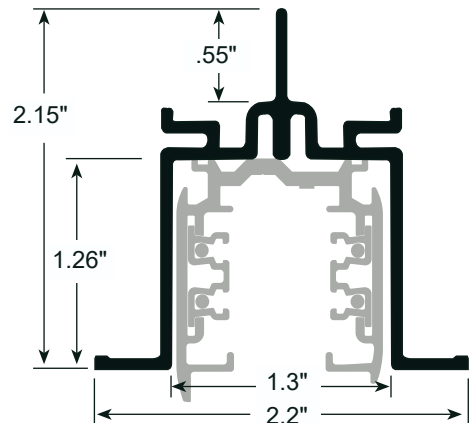

ASL-2 Series Recessed Track Jacket

ASL-2 Series 120V Track Lighting Accessories

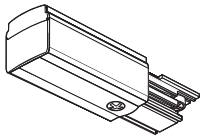

Live End Feed - Left (ASL-211*)

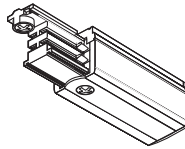

Live End Feed - Right Feed, Mirror of ASL-211* (ASL-212*)

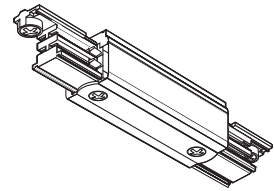

Live Center/Middle Feed (ASL-214*)

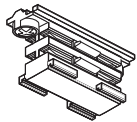

Linear Coupler (ASL-221*)

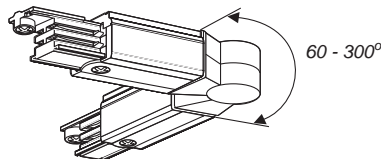

Adjustable Connector (ASL-224*)

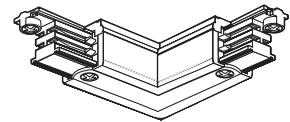

Feed-Able L Connector - Adjustable Polarity (ASL-234*)

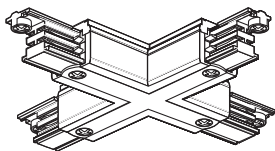

Feed-Able X Connector (ASL-238*)

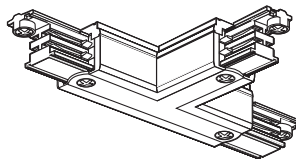

Feed-Able T Connector - Adjustable Right Polarity (ASL-239*)

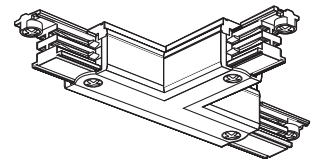

Feed-Able T Connector - Adjustable Left Polarity (ASL-240*)

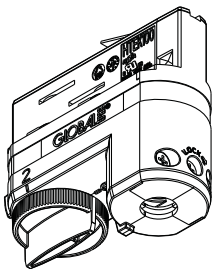

2-Circuit Track Adapter - Switchable Between Circuits (TLA-TEK100*)

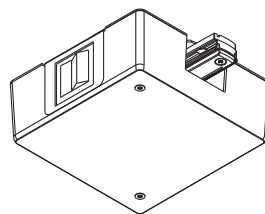

Live End Feed with Circuit Limiter (TLA-TEK-11CB*)

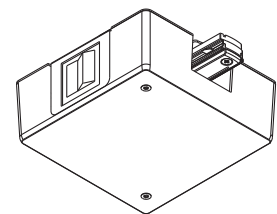

Live End Feed with Circuit Limiter - Mirror of TLA-TEK-11CB* (TLA-TEK-12CB*)

ASL-2 Series 120V Track Lighting Accessories

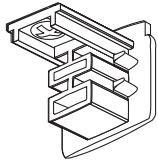

Dean End Cap (ASL-241*)

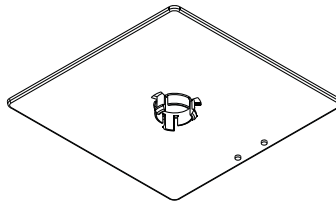

Outlet Box Cover - 5" x 5"
(ASL-A15*)

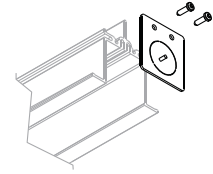

Recessed End Cap - Track jacket
sold separately (ASL-FTP-241*)

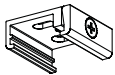

Mount Clip (ASL-2312*)
For direct attachment to hard ceiling or
via 1/4" / 6mm threaded rod (by others)



Ceiling Cup (ASL-2330*)
For use with wire or threaded rod
suspension (sold separately)

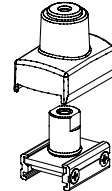

Universal Stem Suspension Point (ASL-SP4P*)
For use with 3/8" or 1/4" stems /
rod (sold separately)

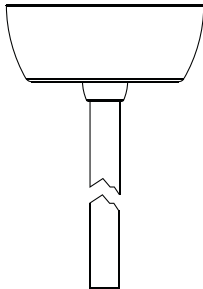

Pendant Stem Kits -
3/8-in. stem with canopy
(ASL-SPUS-12* / 12-inches long)
(ASL-SPUS-18* / 18-inches long)
(ASL-SPUS-24* / 24-inches long)
(ASL-SPUS-48* / 48-inches long)
Attachment point to track sold separately.
Custom lengths available. Contact your
regional sales manager for assistance.



Suspension Wire -
3/8-in. stem with canopy
(ASL-2334-1* / 5-feet long)
(ASL-2334-9* / 9-feet long)
Attachment point to track sold separately.



Recessed T-Bar Ceiling Clamp ASL-2314*)
Clamp for recessed T-bar installations



T-Bar Ceiling Clamp ASL-2313*)
Clamp for T-bar installations

Ordering Information

ASL-2 Series 2-Circuit, 120V Track

The track and accessories are available in black or white powder coat or silver anodized (as noted).

ASL-2 Series Track - TEK Specification Grade 2 Circuit (120V) Track System

Model	Description
TLA-TEK100-*	2 Circuit Track Adapter Installed (Switchable Between Circuits & On/Off)

*Note: * Add one of the following codes for track finish: -2 Black, or -3 White.*

2 Circuit Track (2 Hots & 2 Neutrals)

Model	Description
ASL-2004**	4' Surface Mount, 2 Circuit, 120V Track
ASL-2008**	8' Surface Mount, 2 Circuit, 120V Track
ASL-2012**	12' Surface Mount, 2 Circuit, 120V Track

*Note: ** Add one of the following codes for track finish: -1 Silver (natural finish), -2 Black, or -3 White.*

ASL-2 Series 120V Track Accessories

TEK Track - Recessed Track Jacket

Model	Description
ASL-FTP-244*	4'-3.5" Recessed 2 Circuit Track Jacket (Not Including Track)
ASL-FTP-248*	8'-3.5" Recessed 2 Circuit Track Jacket (Not Including Track)
ASL-FTP-2412*	12'-3.5" Recessed 2 Circuit Track Jacket (Not Including Track)

TEK Track - Connectors, Caps, and Tool Accessories

Model	Description
ASL-211*	Live End Feed - Left
ASL-212*	Live End Feed for Mirror Image - Right
ASL-214*	Live Center/Middle Feed
ASL-TEK-11CB*	Live End Feed with Current Limiter for TEK 120V Track - Left Live End Feed
ASL-TEK-12CB*	Live End Feed with Current Limiter for TEK 120V Track - Right Live End Feed
ASL-221*	Linear Coupler
ASL-224*	Adjustable Connector
ASL-234*	Feed-able L-Connector, Adjustable Polarity
ASL-238*	Feed-able X-Connector
ASL-239*	Feed-able T-Connector, Adjustable Right Polarity
ASL-240*	Feed-able T-Connector, Adjustable Left Polarity
ASL-241*	Dead End Cap
ASL-FTP-241*	Recessed End Cap
ASL-A15*	Outlet Box Cover
ASL-370*	Monopoint, Surface Mount
ASL-BT	Bending Tool

*Note: * Add one of the following codes for track finish: -2 Black, or -3 White.*

ASL-2 Series 120V Track - TEK Mounting

TEK Track - Mounting and Suspension Accessories

Model	Description
ASL-2312*	Mount Clip
ASL-2313**	T-Bar Ceiling clamp
ASL-2314**	Recessed T-Bar Ceiling clamp
ASL-2330**	Ceiling Cup
ASL-2332**	Plastic Covering Tube, 65' length
ASL-2334-1	5' Suspension Wire
ASL-2334-9	9' Suspension Wire

Notes:

* Add one of the following codes for track finish: -2 Black, or -3 White.

** Add one of the following codes for track finish: -1 Silver (natural finish), -2 Black, or -3 White.

TEK Track - Pendant Stem Kits and Mount

Model	Description
ASL-SPUS-12*	12", 3/8" Stem with Ceiling Canopy
ASL-SPUS-18*	18", 3/8" Stem with Ceiling Canopy
ASL-SPUS-24*	24", 3/8" Stem with Ceiling Canopy
ASL-SPUS-48*	48", 3/8" Stem with Ceiling Canopy
ASL-SP4P*	Universal Stem Suspension Point

Notes:

* Add one of the following codes for track finish: -2 Black, or -3 White.

Custom stem lengths available (up to 9'). Contact your regional sales manager for assistance.

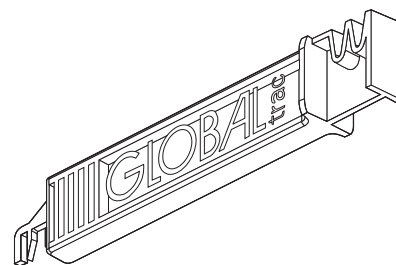

The ASL-BT is an all-in-one hand tool that bends conductors to the track manufacturer's specifications and includes gauge to verify correct length.